



PlayStation

NTSC U/C

PlayStation

CRASH

BANDICOOT



KIDS TO ADULTS



CONTENT RATED BY
ESRB

SCUS-94900
94900

NAUGHTY DOG

universal interactive studios



SONY



COMPUTER
ENTERTAINMENT

WARNING: READ BEFORE USING YOUR PlayStation™ GAME CONSOLE.

A very small percentage of individuals may experience epileptic seizures when exposed to certain light patterns or flashing lights. Exposure to certain patterns or backgrounds on a television screen or while playing video games, including games played on the PlayStation game console, may induce an epileptic seizure in these individuals. Certain conditions may induce previously undetected epileptic symptoms even in persons who have no history of prior seizures or epilepsy. If you, or anyone in your family, has an epileptic condition, consult your physician prior to playing. If you experience any of the following symptoms while playing a video game – dizziness, altered vision, eye or muscle twitches, loss of awareness, disorientation, any involuntary movement, or convulsions – IMMEDIATELY discontinue use and consult your physician before resuming play.

WARNING TO OWNERS OF PROJECTION TELEVISIONS:

Do not connect your PlayStation game console to a projection TV without first consulting the user manual for your projection TV, unless it is of the LCD type. Otherwise, it may permanently damage your TV screen.

HANDLING YOUR PlayStation™ DISC:

- This compact disc is intended for use only with the PlayStation™ game console.
- Do not bend it, crush it or submerge it in liquids
- Do not leave it in direct sunlight or near a radiator or other source of heat.
- Be sure to take an occasional rest break during extended play.
- Keep this compact disc clean. Always hold the disc by the edges and keep it in its protective case when not in use. Clean the disc with a lint-free, soft, dry cloth, wiping in straight lines from center to outer edge. Never use solvents or abrasive cleaners.

HINT LINE

Hints are available:

Within the U.S. 1-900-933-SONY (1-900-933-7669)
 \$0.95 per minute pre-recorded information
 \$1.15 per minute live representative assistance
 \$4.95 for mailed out tips

Within Canada 1-900-451-5757
 &1.25 per minute (U.S. dollars)

For U.S. callers, game counselors are available Monday-Friday, 8AM-6PM, Pacific Standard Time. Associated Support is available 24 hours a day, 7 days a week.

In Canada, automated support is available 24 hours a day, 7 days a week. Live support is not available at this time.

This hint line supports games produced by Sony Computer Entertainment America and Psygnosis Limited. No hints will be given on our Consumer Service Line. Callers under 18 years of age. Please obtain permission from a parent or guardian before calling. This service requires a touch tone phone.

CONSUMER SERVICE/TECHNICAL SUPPORT/ORDER LINE

1-800-345-SONY(1-800-345-7669)

Call this number for help with technical support, installation or general questions regarding the PlayStation™ game console and its peripherals. Representatives are available Monday-Friday, 8AM-6PM Pacific Standard Time.

SONY ONLINE

<http://www.sony.com>

Our news is always hot! Visit our website and find out what's happening at Sony - new titles, new products and fresh tidbits about the PlayStation™ game console.

CRASH

BANDICOOT™

TABLE OF CONTENTS

Start Up Information	2	Bonus Rounds	11
Introduction/Controllers	3	Stage Clear/Gems & Keys	12
Heroes are made, not just born	4	Island Hopper/Walk Through	12-16
Controls	5	Remaining Stages of Island 1	17-18
Starting the Game/Pause	6	Cast of Characters	19-22
Game Over/Saving	7	Notes	23
Playing the Game	8	Credits	24
Defending yourself	8	Warranty	25
Boxes	9-10		

ESRB RATING

This product has been rated by the Entertainment Software Rating Board. For information about the ESRB ratings, or to comment about the appropriateness of the rating, please contact the ESRB at 1-800-771-3772.

START-UP INFORMATION

Set up your PlayStation™ game console according to the instructions in its Instruction Manual. Make sure the power is **OFF** before inserting or removing a compact disc. Insert the Crash Bandicoot™ disc and close the CD door. Insert game controllers and turn on the PlayStation™ game console. Follow on-screen instructions to start a game.

Console

Top View

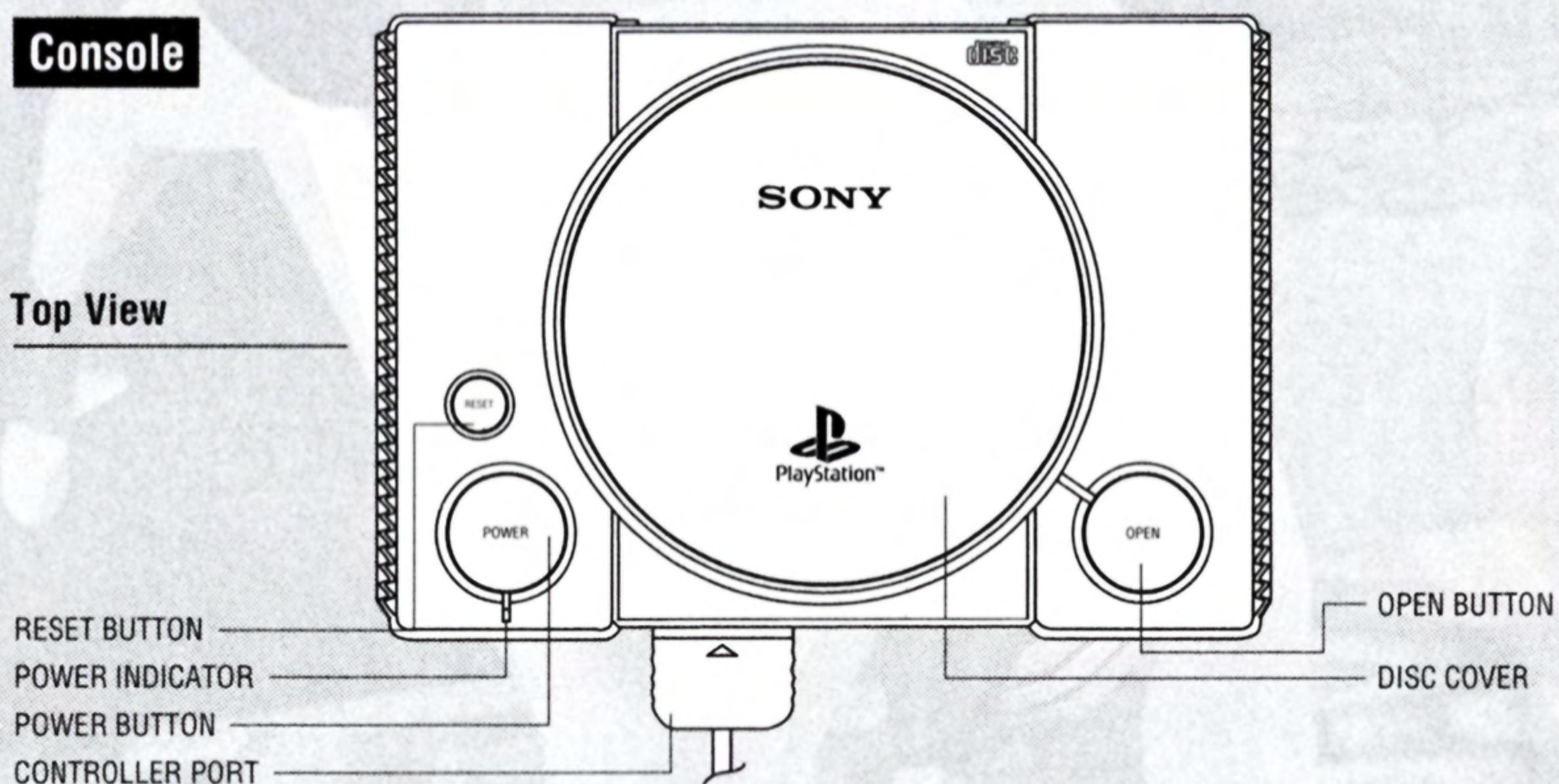

Console

Front View

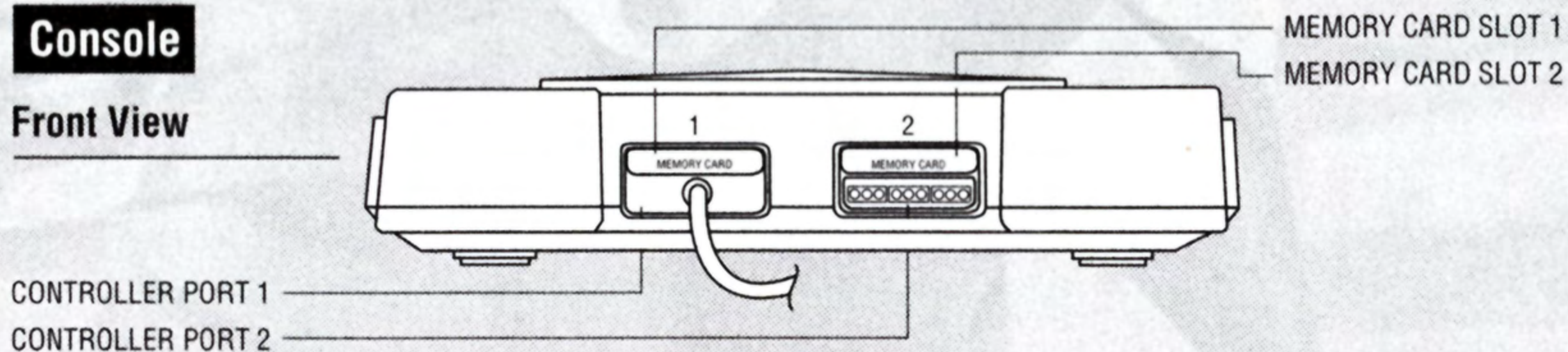

INTRODUCTION

Welcome to the lands Down Under! It's safe to say you may not know much of the local real estate around here, so we'll bring you up to speed. For starters, there's this creep named Dr. Neo Cortex who owns three of the nicest little islands just southeast of Australia. He's up to some strange experiments with the local marsupials and other critters, and it doesn't look good. He even had the nerve to mess with a bandicoot! Dr. Cortex up and altered the genes of Crash and now we have a perfectly good hero waiting for an opportunity to shine. We'll tell you about that on page four.

Controller

Front View

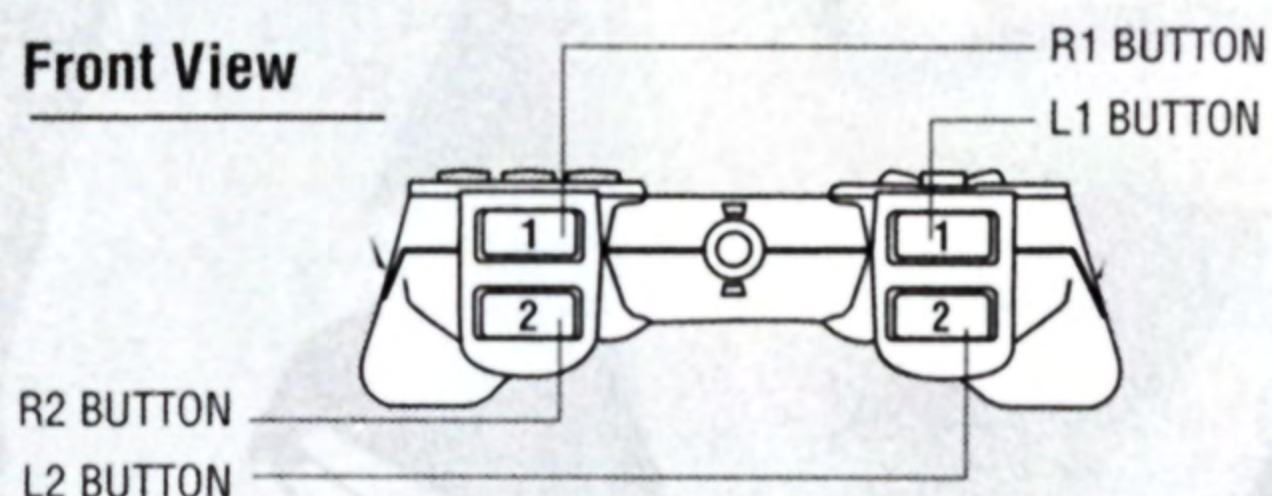

Controller

Top View

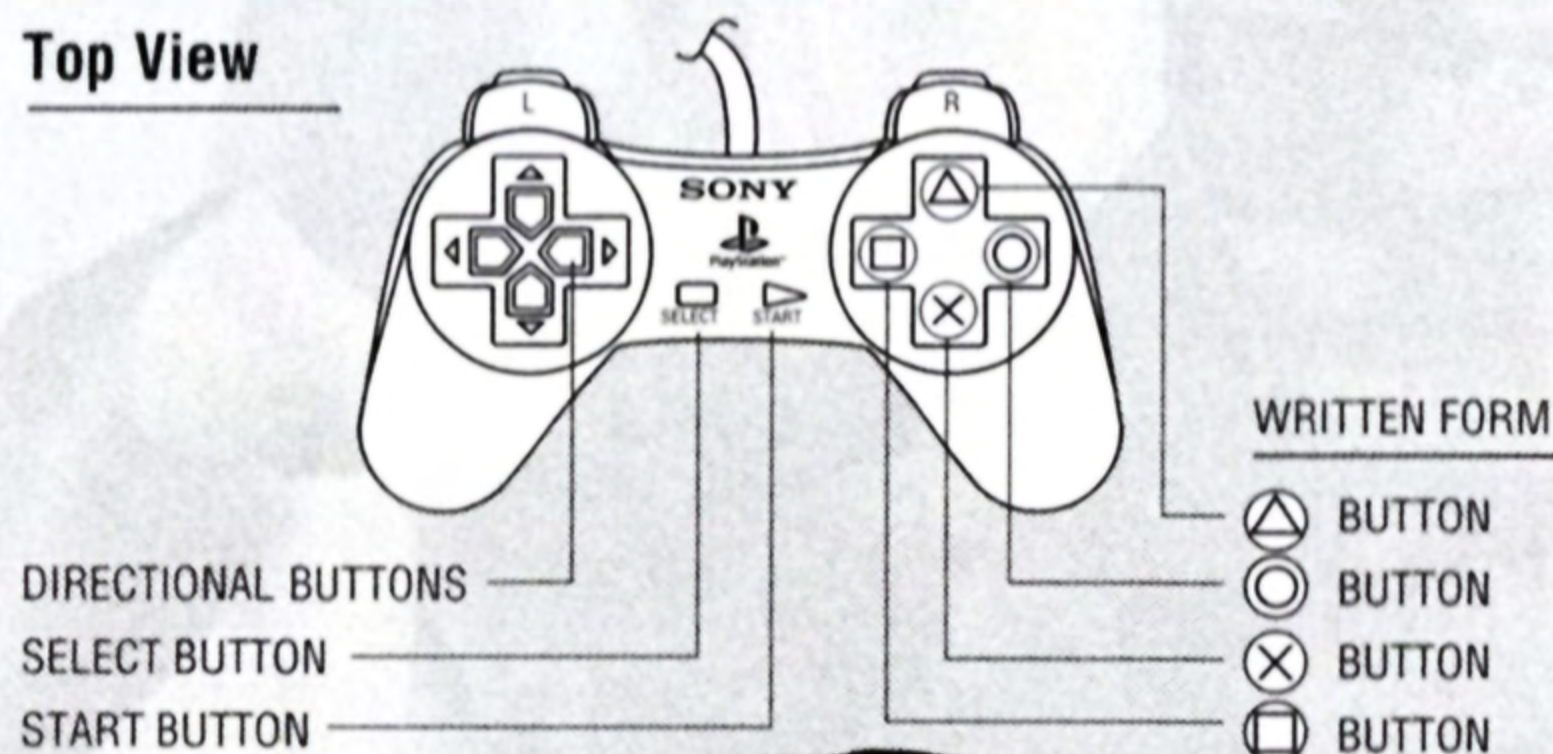

HEROES ARE MADE, NOT JUST BORN

Where were we? Oh, yes – a hero for our time. Now, Crash Bandicoot, although he was made (sort of) by the demented Dr. Cortex, he was dismissed as “unworthy” to be in the Doctor’s growing army of animal-based soldiers. It seems that Cortex has grander plans than Crash could fulfill, so he up and boots Crash off his main island and goes back to his schemes of world conquest.

That was a very big mistake.

It turns out that before Crash was ejected from the island fortress, he made an attachment to another one of Cortex’s experiments – a wonderful she-bandicoot named Tawna. Crash is rather upset about being distanced from his new love and he’s going to prove just how wrong Dr. Cortex was in making a Bandicoot (new and improved, at that!) as an enemy for life. Stick around for the fireworks, the fun is just starting!

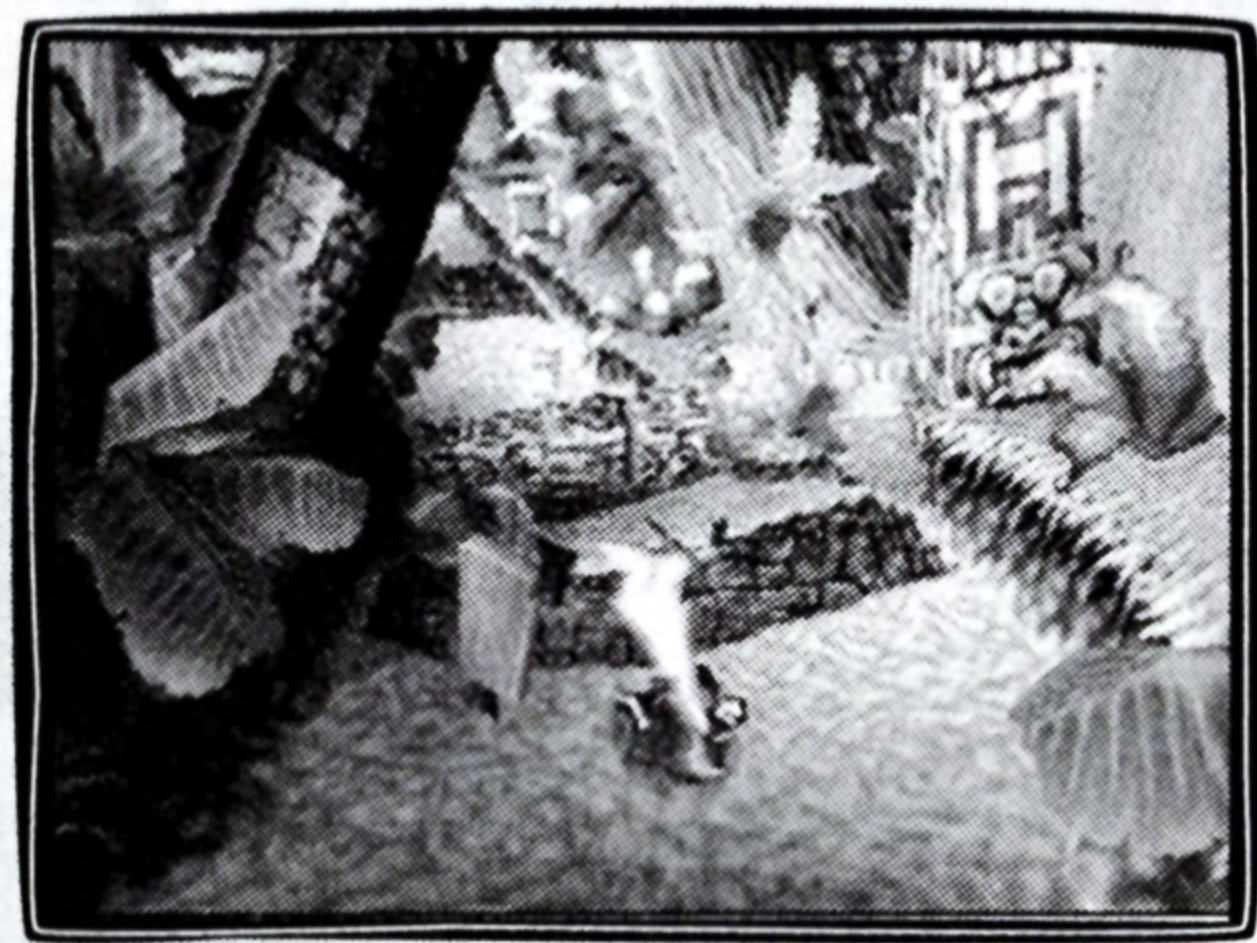

CONTROLS

Crash has a very basic set of moves. He runs, jumps and has a spin attack, but he does it facing in every direction. For instance, Crash can move left and right (you've seen that, right?). Well, he can also move into the screen (away from you) as well as directly towards you.

THE CONTROLS ARE LISTED BELOW:

- | | |
|--------------|--|
| ↑ | Move Crash forward |
| ↓ | Move him back |
| → | Move right |
| ← | Move left |
| □ BUTTON | Spin |
| ⊗ BUTTON | Jump |
| ○ BUTTON | Spin |
| △ BUTTON | Inventory Status
- This brings down the Status Bars showing how many pieces of fruit you have collected and how many lives you have left. |
| START BUTTON | Pauses/resumes the game |



This may get a bit confusing because the button controls don't change when his position does. So you may have to re-think a couple of moves on the fly or the next thing you know, you're getting flattened by a rolling boulder. Just remember, push Right when you want him to move to your right (no matter which way he's facing) and so on with the other direction buttons.

THE GAME

STARTING THE GAME Set the disc in the disc holder, turn the PlayStation™ game console **ON**, and close the cover. Press **START** to start the game.

When you get to the first island, you're ready to begin the adventure. Hold on tight and press the **⊗** **BUTTON** to begin the level.

Crash is transported to the first of three islands and has a **3D** world of trouble to get through for his beloved Tawna.

PAUSE You can pause at any time but you can only quit the level if you are standing on the ground. Pressing **START** freezes the game play and offers you a choice between restarting the game where you froze it, or going back to the Main Map screen by pressing the Select Button. If you press the Select Button while Crash is on the Map Screen, you will quit the game.



THE GAME

GAME OVER If you lose all of your lives at any point in the game, you see this screen. Press Yes to continue from the last **SAVE POINT** you earned.

SAVING THE GAME: Memory Cards/Passwords

An in-game Saving System allows you to record data to a memory card at certain **SAVE POINTS** during the game. Once you are in the game itself, you can use the **SAVE** feature to update your progress into a **MEMORY CARD**. The **SAVE POINTS** are located in the Tawna Bonus Rounds. At various other points you will be given the opportunity to record the fact that you've earned a gem or key.

There is also a Password feature which will allow you to return to where you last saved. Write down passwords for future use. They are between 8 and 24 characters long (depending on whether you have collected gems along the way...). Use the handy Notes section in this instruction manual to jot down your earned passwords.



PLAYING THE GAME

So there you are, stranded on a desert isle, surrounded by fierce bandicoot-eating monsters and wicked death-traps. Sounds like fun to us! Here's what you do next:

DEFENDING YOURSELF Crash has two types of attacks, Jumping and Spinning. Press the Jump Button to launch Crash into the air and aim his landing on an enemy character. Use his shadow to help you determine where to land. Some enemies need more than a successful jump attack to knock them off the screen, but you'll figure them out when you run into them.

The Spin Attack is more powerful than the Jumping Attack. When Crash makes a successful Spin Attack, the critters end up right off the screen. Time Crash's spin just right or a lucky nip from a hungry monster will cost you a life.

You'll also notice that you can direct the "kicked" enemy into another enemy that is on-screen at the time. Master this move to earn some big bonuses! Just a note: If you use a Spin Attack to launch an enemy into a box, the box opens as if Crash himself gave it a kick. This can be good and it can be bad...

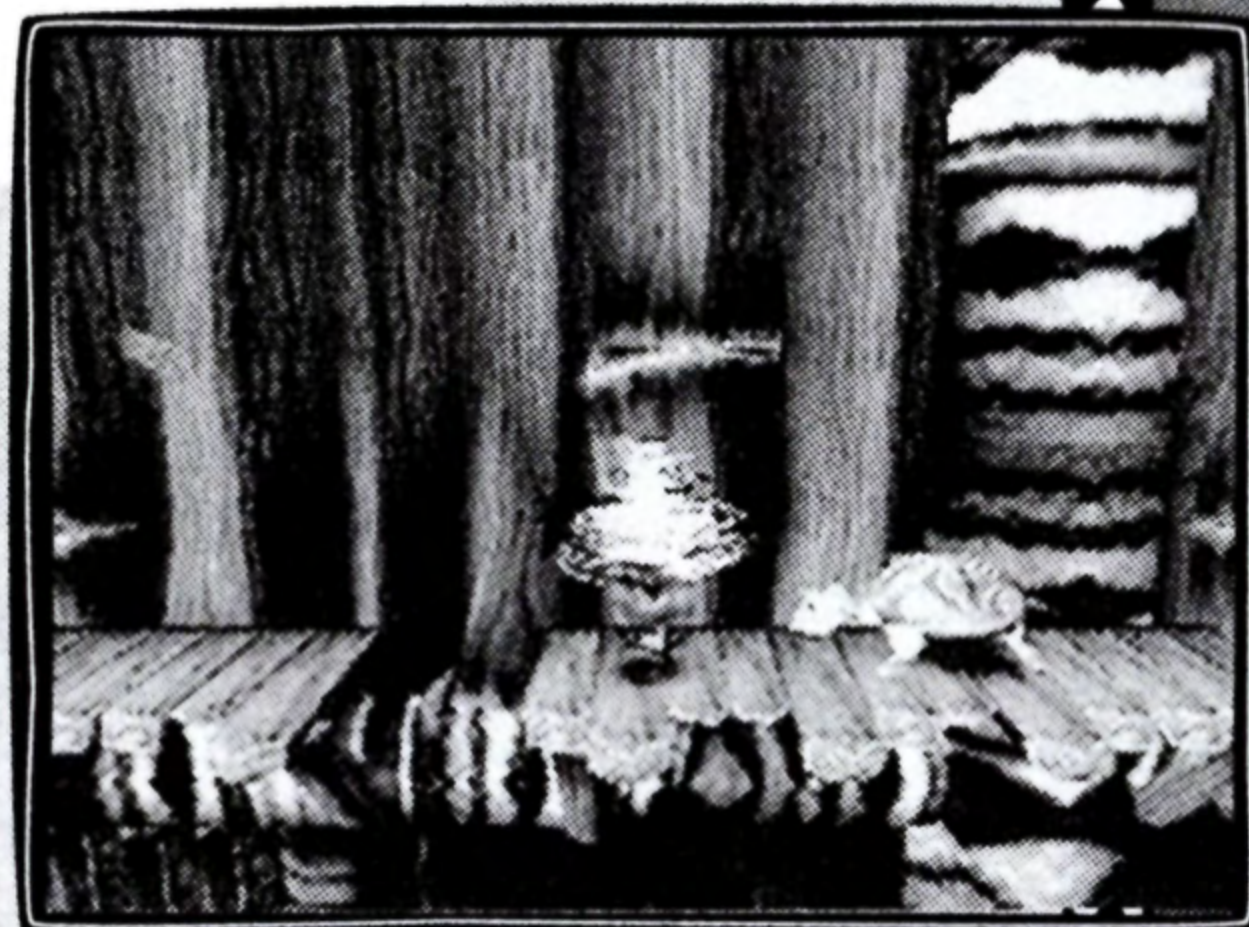

Use these moves to open the boxes in each of the stages as well. A word of caution: don't go spin-kicking open all of the boxes. Some can be jumped on to get more treasures than a Spin Attack will allow.

BOXES - Half the fun of any adventure is the stuff you get to collect along the way. Crash has a whole bunch of treats just waiting for a well-timed kick or jump to release them from their crates. Some boxes have an icon of what's inside of them printed on the outside. Others leave it to a surprise factor. Either way, it's usually best to open the ones you come across. Some of the boxes contain the following items:

WUMPA FRUIT - Collect 100 pieces to earn a free life (1-Up).

WITCH DOCTOR'S MASK - These lovelies help insulate Crash from most bad moves. When possessing a Mask, Crash is shielded from one enemy's attack or contact. Collect three Masks to earn a temporary invulnerability from all minor dangers.

BOUNCE - Like arrow boxes, bounce boxes can be jumped upon several times to earn multiple prizes. They look almost like regular boxes except...

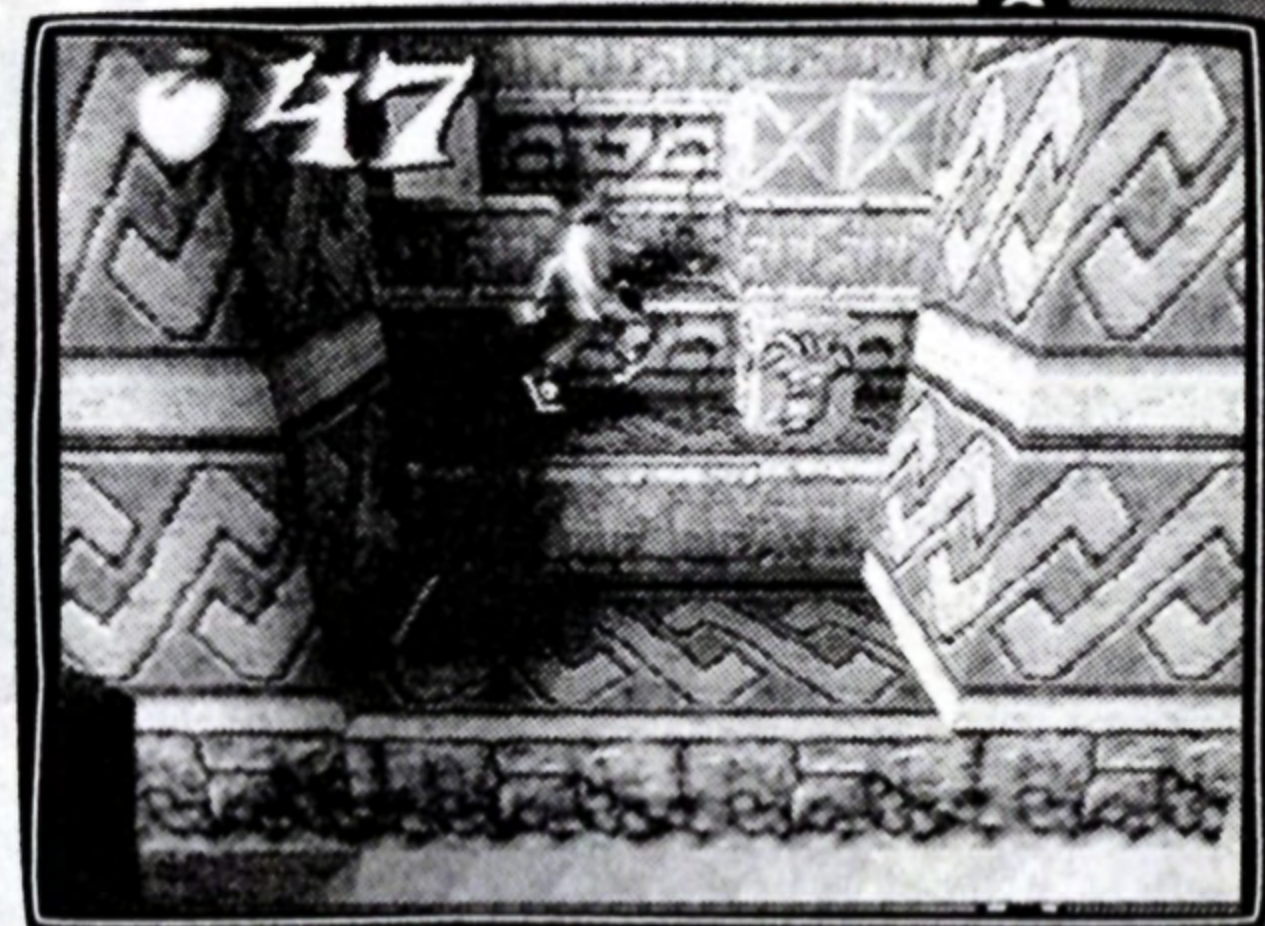

BOXES (CONT.)

ARROW - Boxes with arrows (pointing Up), let you know two things: first, there is something good waiting for you when you Jump on top of this box. Second, you may need to keep jumping successfully to earn more bonuses or fruit from this box. You can only open an Arrow box by using the Spin Attack. If you happen to do this before Jumping on it - then tough darts.

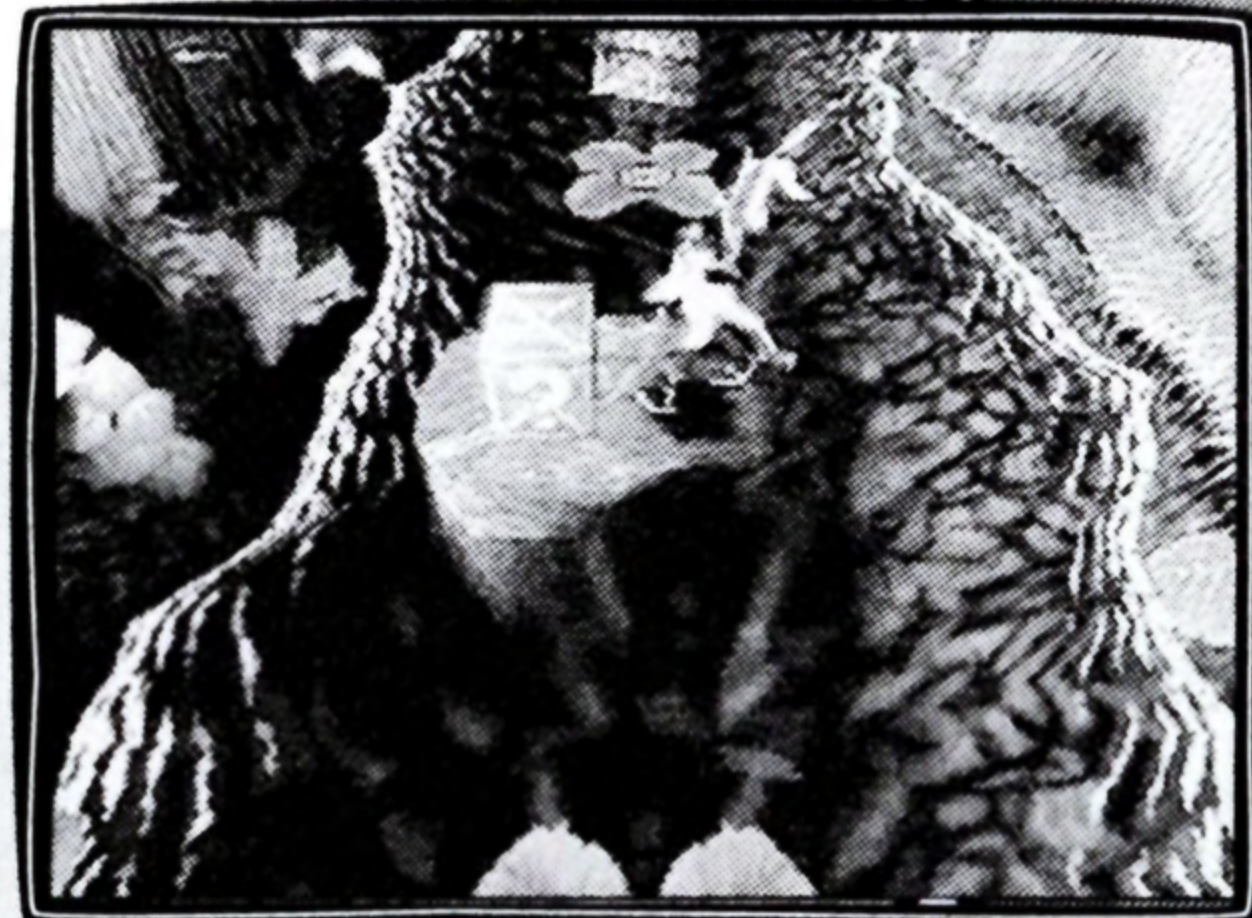

? - Who can say what's in these crates? You'll just have to find out for yourself.

! - Similar to the above entry, but these boxes may cause something in the background to change.

TNT - Jump on this to start the 3 second fuse. Don't hang around for the explosion or Crash will need more than some glue to be reassembled. NEVER EVER Spin Attack a TNT box. (Just a suggestion.)

CRASH - If you see a box with a heroic-type mug on it, it's usually containing a 1-UP for Crash. Collect this to earn a free life.

C - CHECK POINT. Allows you to return to the stage where you opened the first box. If you opened more than one box in a stage, you'll return to the location of the last opened box.

BONUS - Contains either Tawna, N. Brio or Cortex tokens.



BONUS ROUNDS

You can also find tokens inside boxes. These tokens may feature the likenesses of Tawna, Dr. Neo Cortex or Dr. N. Brio (two uglier mugs you'll be hard-pressed to find).

Once you collect three (3) tokens in one stage, the action freezes on-screen and Crash is immediately transported to a Bonus Round. Once he's here, the wily bandicoot can Jump and Spin Attack a ton of boxes to earn bonus fruit and items like keys to hidden rounds. If he slips and falls off the screen you don't lose a life, you just get Crash transported back to the level he started from. This also happens once he's completed the Bonus Round and steps on the Sparkling Transport Pad. You can only save on Tawna Rounds.

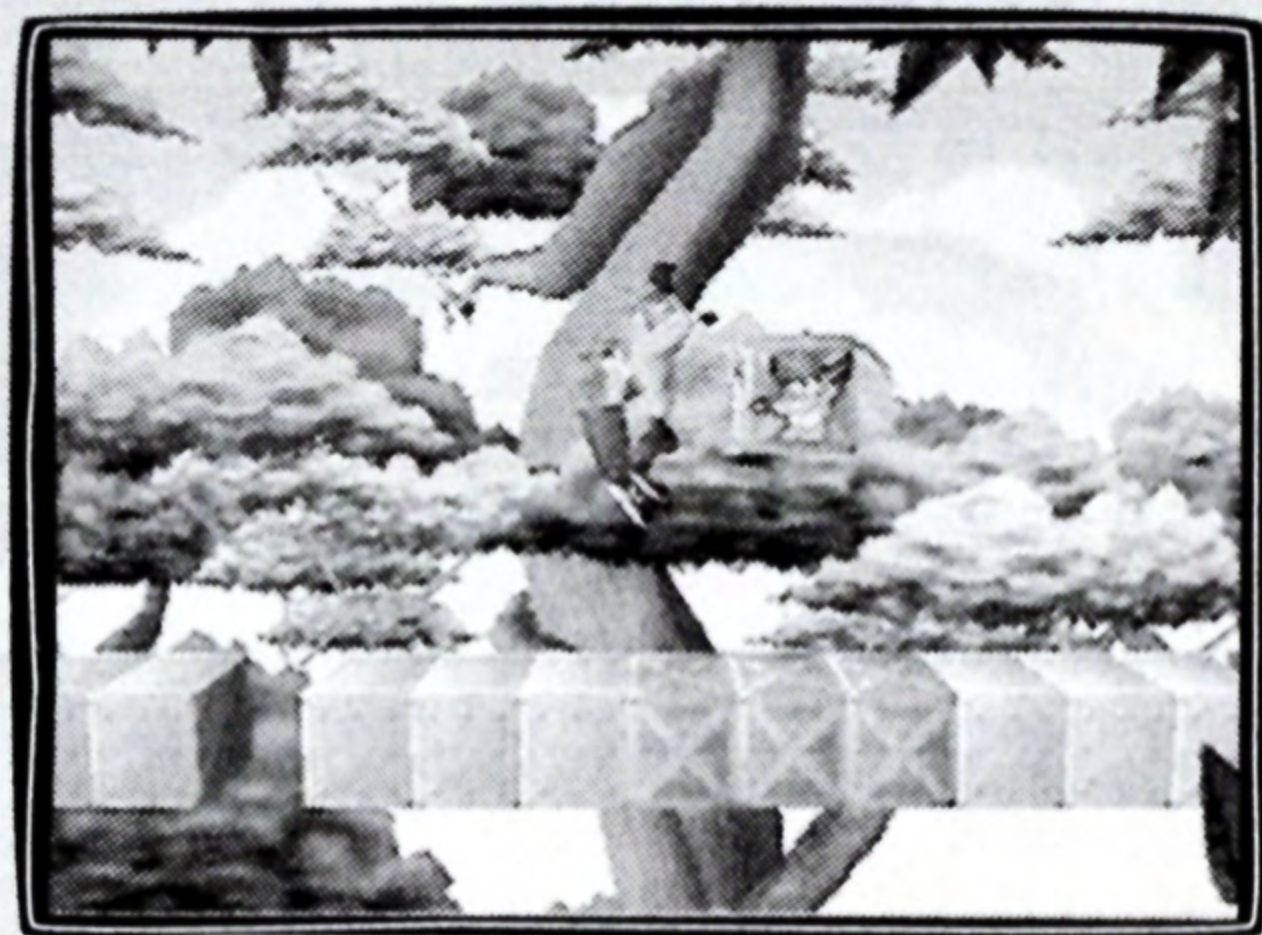
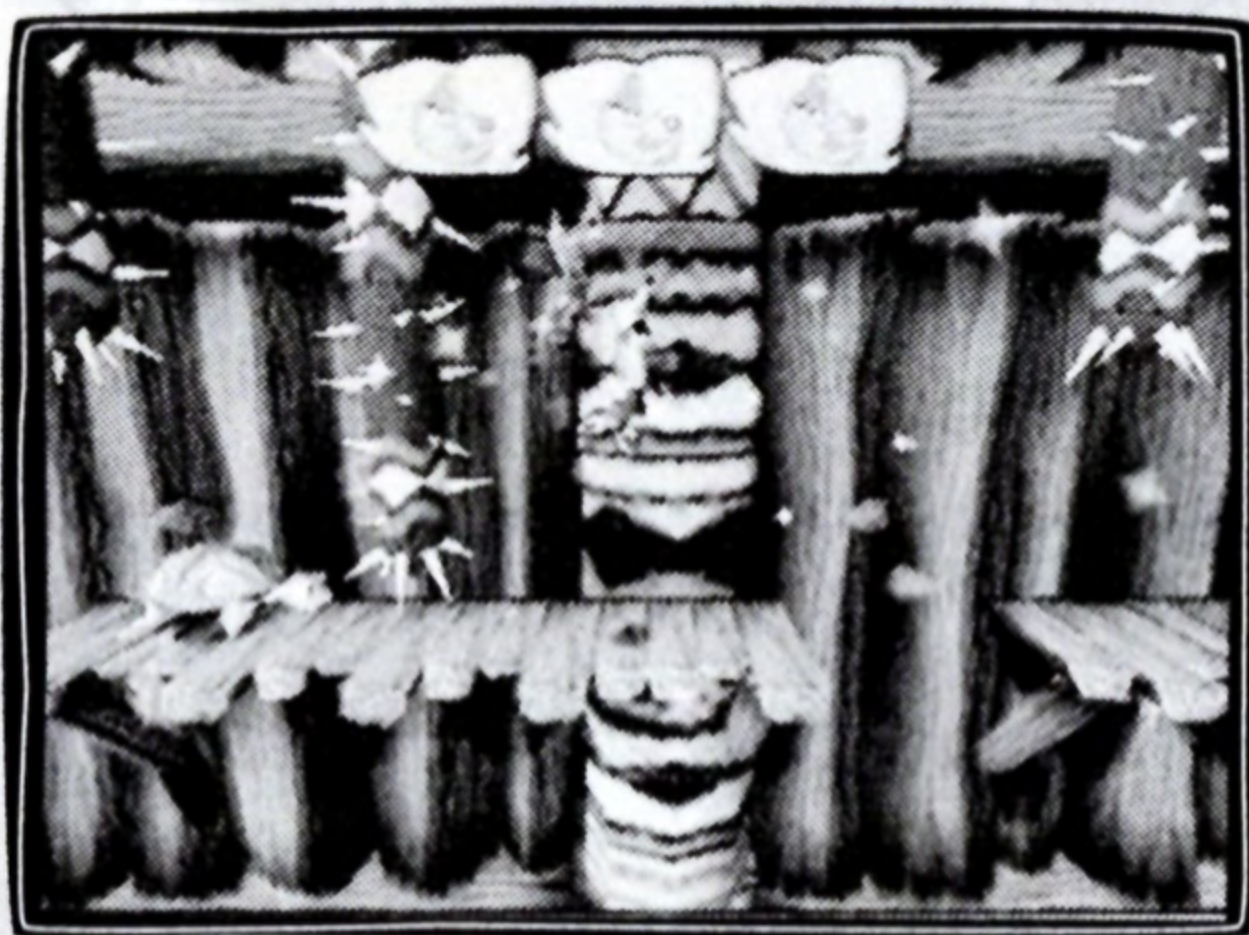

STAGE CLEAR

If you make it all the way through a level in one life, Crash will show up in the Stage Clear Area. This area lets you know how well you did and if you earned any particularly keen bonuses. If you did lose a life during the stage, then you'll just go back to the Main Map Screen. You'll also find out how many boxes you missed along the way. This will give you an idea of just how good you are at spotting all the secret areas, hidden items and, well, that would be telling now, wouldn't it?

Press the **START BUTTON** to go back to the Main Map Screen.

GEMS AND KEYS - You can earn valuable Gems and Keys. Gems may be awarded in Stage Clear and Keys may be awarded in the Bonus Rounds (you just have to figure out how?!). Once you do, the levels that offer these items display the Gem or Key icons at the top of the screen in the Map Screen. Collect Gems to enable Crash to return to stages that he has previously completed to enter new areas (that were not originally open to him). Keys allow Crash access to secret areas as well. Good luck in hunting down these rewarding areas!

HINT: Gems can only be earned by getting through a level without losing one Crash and by breaking open all of the boxes.

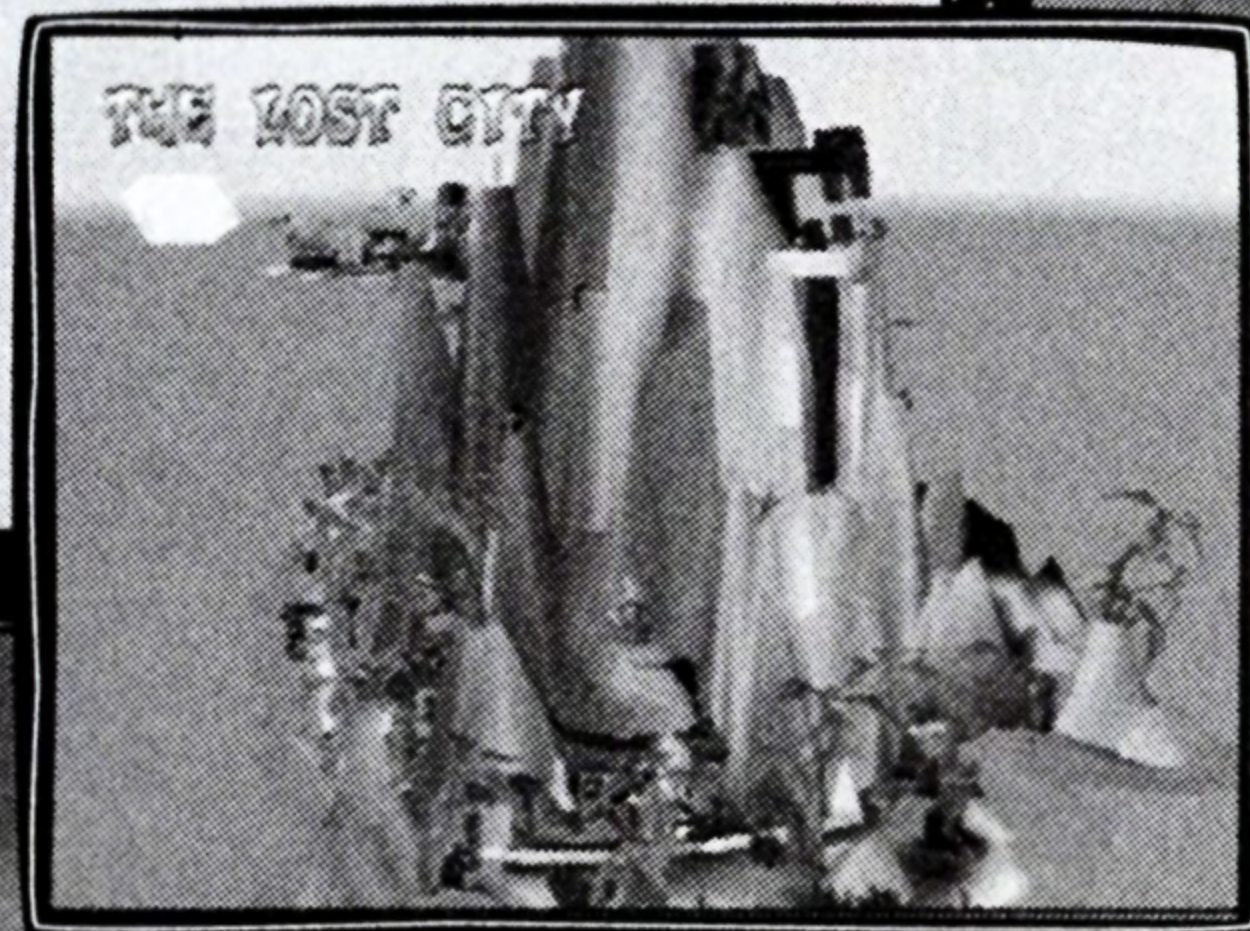

ISLAND HOPPER

These are actual island stages and what you can expect on them. Expect danger! That almost goes without saying, but that's why we give you so many lives in the first place.

We have included a step-by-step walk-through of the first island stage, N. Sanity Beach, to give you an idea of the kind of obstacles and hazards you will come up against. If you want to find these out for yourself, just skip this description and go to the next one.

Also listed in this section are the names of the various stages of the first island. They are listed in order of appearance for those of you who keep track of these things.



1. N. SANITY BEACH - THE WALK-THROUGH

Here's where you learn the fine art of being a Bandicoot. Practice your jumps and Spin Attacks in this stage—you're going to need expert timing by the time you get to the next stage.

WALK THROUGH (CONT.)

The stage begins with Crash washing up on the shore of N. Sanity Beach. Because this is real estate still owned by Dr. Cortex, Crash is in danger. The evil experimenter has peppered his island with a number of threats that are just waiting to add "Bandicoot" to their dietary menu. Keep this in mind as you begin your journey.

The first set of boxes for this stage are right in front of Crash. Two of the boxes are of the Bounce variety - have Crash jump on them to gain the multiple fruits inside. Once the boxes are empty, the box itself breaks under his weight. The third box has a "?" on it. Inside is a 1-Up (free life). After collecting these items, move down the path. You'll see a crab in your way. Jump on him or Spin Kick him off the screen. Once you pass the crab, you'll see the first (of many) pits that Crash has to jump over. Fall in the pit - lose a life. The next thing that comes across your path is a box containing a Witch Doctor's Mask. Break open the box and grab this



item to gain protection from one level of an enemy's attack. (See the description of this item for more details.) The next box you'll run across (a "?" box) has a piece of fruit in it. You'll then have an opportunity to jump on an Arrow box for multiple pieces of fruit. Get past another crab, break a box with one piece of fruit in it, jump over two pits, defeat another crab, and break two more boxes (with fruit), before you come to a vertical climb.

There are several boxes along the climb to the top that feature: numerous fruit, another Witch Doctor's Mask, and a 1-Up. You'll encounter a steel box (that doesn't do or have anything for Crash). Just ignore it and move on to the top, opening all the wooden boxes along the way. Once Crash makes it to the top, you'll get a "C" box. Break it open to earn a CHECK POINT. This is where you'll continue from if you lose a life. You'll then get the third Witch Doctor's Mask (and if you haven't

been hurt up to this point, you'll become temporarily invulnerable from everything but a fall down a pit). The next set of obstacles are: beat a turtle, jump a pit, beat a turtle, jump a pit, and beat a turtle. Open three boxes, pick up more fruit, jump a blockade (hey, slow down, there's a box wedged in behind the blockade). Jump another pit and open eight boxes. You should have collected over 100 pieces of fruit by now to earn another 1-Up.

You'll now be facing a fork in the road. Go left. Collect the items in the boxes along the way and be sure to get rid of the turtle. When you come to a pit GO BACK. You can now proceed down the right side of the fork in the road. Jump a pit and kick the box marked with an "!" to make a bridge of boxes appear. Hop on the boxes to get the items inside (but be careful, it's a long drop to the bottom). One of the bridge boxes contains a 1-Up. After crossing the bridge, you only have one turtle and a couple of boxes between you and the exit pad. Jump on the exit pad to beam on out of there.

THE REMAINING STAGES OF ISLAND 1

2. **JUNGLE ROLLERS** - Imagine Crash's surprise when a 5 ton roller meets up with his fur. In a word - Ouch! Timing is the key.

3. **THE GREAT GATE** - Think Up. Movement is more vertical than before. Oh, you can press the Jump Button while using a Bounce Box to increase your altitude.

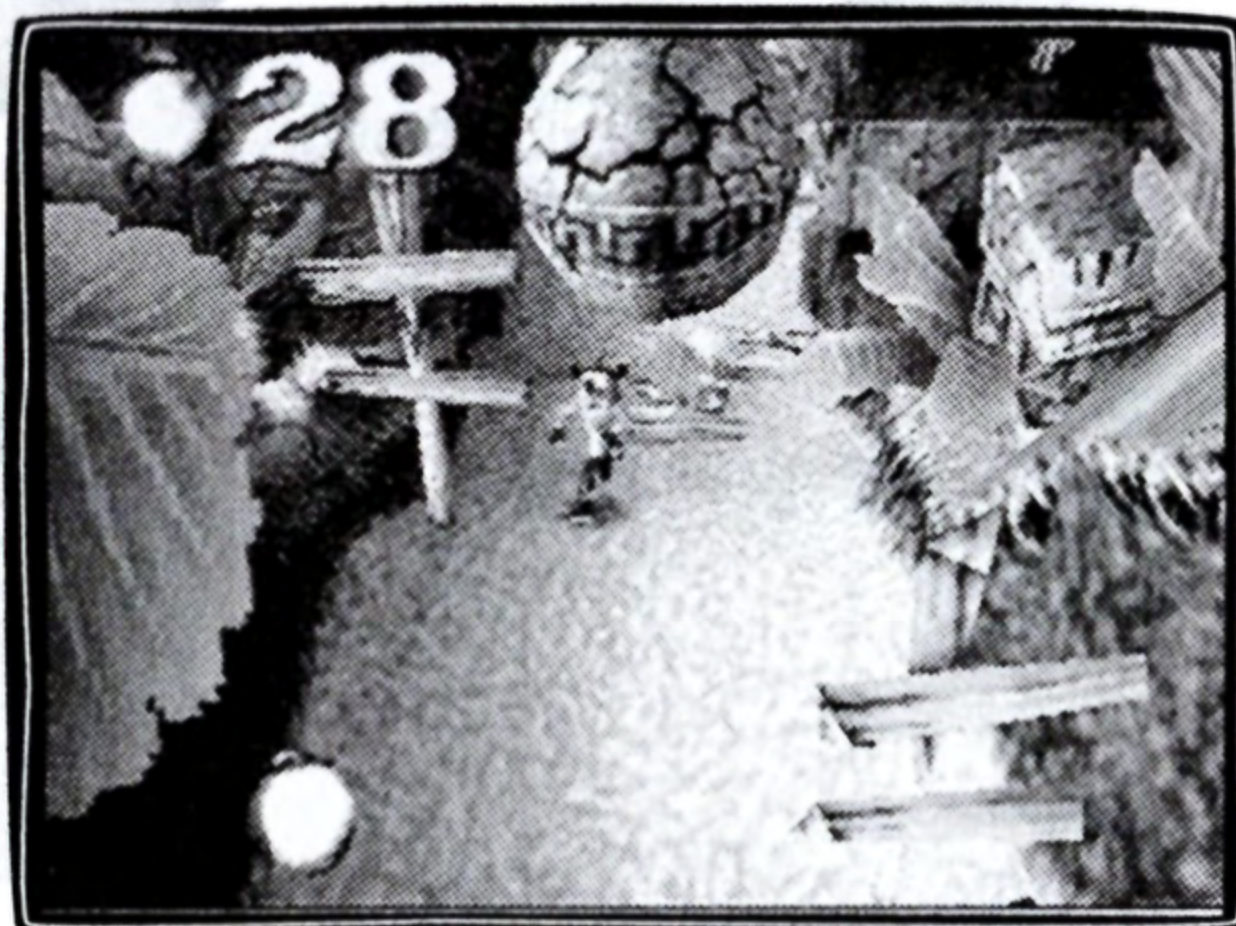

4. **BOULDERS** - Run. Hint: Run. Another hint: Don't slow down, RUN!

5. **UPSTREAM** - The only thing a dip in this river will do for Crash is permanently soak his fur (and, of course, cost you one life). Be sure to point in the right direction before you make those critical leaps.

THE REMAINING STAGES OF ISLAND 1

6. PAPU PAPU - This big bloke swings a club that really smarts! Avoid the big guy's swings and do your best to find a weak spot.

7. ROLLING STONES - More of what made Jungle Rollers so unforgettable, but positioned to better challenge your newly honed reflexes.



8. HOG WILD - Take a wild ride on a tusked steed, but do be careful to avoid the many hazards and pitfalls that will add Pork to the Bandicoot dinner the locals are craving.

9. NATIVE FORTRESS - Think Up again with a twist. Get out of here in one piece, and you'll be ready to take on a whole new island!

CAST OF CHARACTERS

CRASH BANDICOOT - What can we say about this heroic, seriously agile, recently evolved marsupial that we haven't said all through this manual? Not much? Okay, well you might like to know that he really does enjoy a good tussle every now and then. And since this whole thing is for his girlfriend Tawna, so much the better!

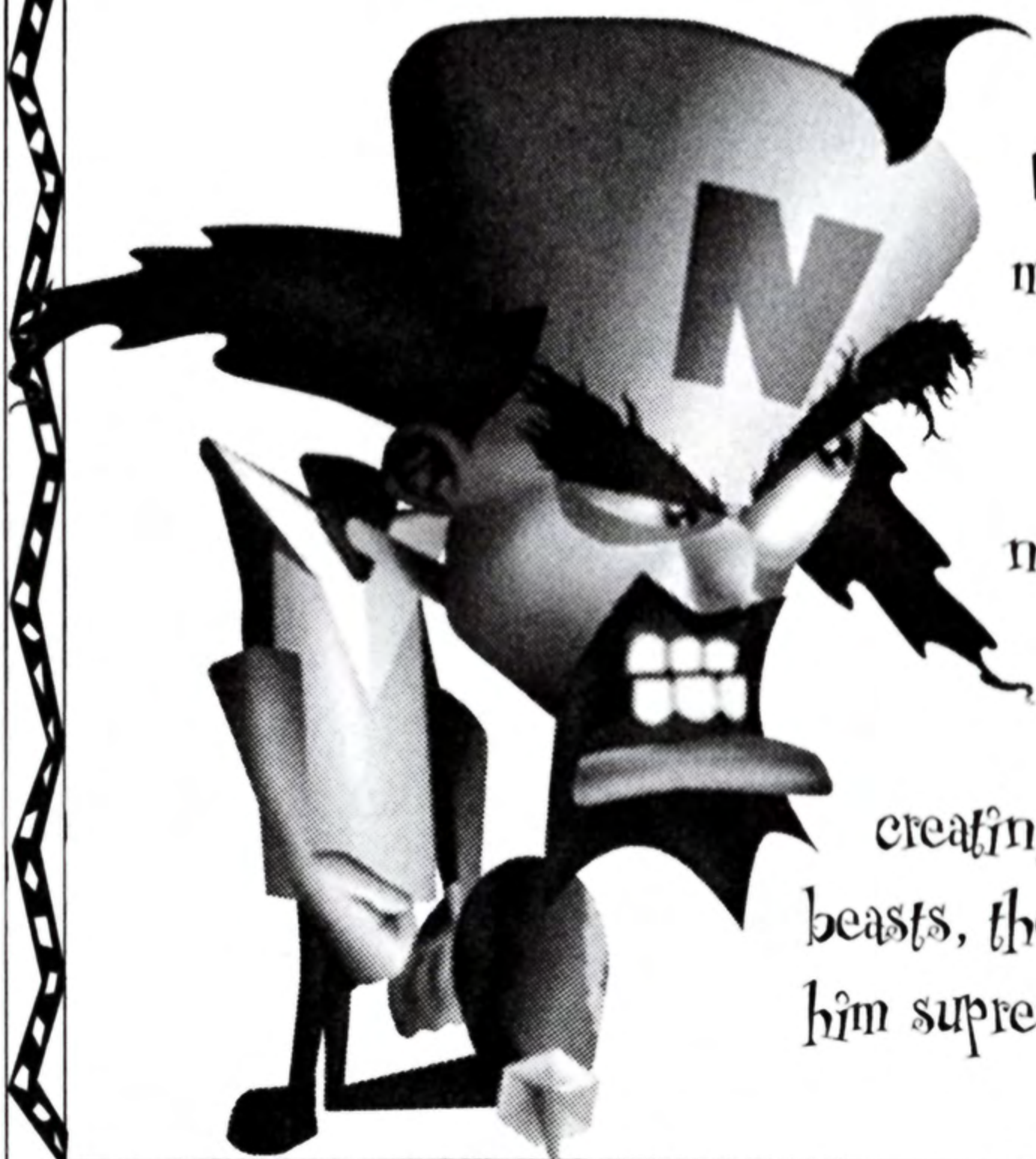

DR. NEO CORTEX - His early years truly molded this wretched creature into the Mad Scientist he is today. Often ridiculed by the scientific community for his outlandish (yet nearly workable) theories, Dr. Cortex is motivated by one driving force - to shut those know-it-alls up once and for all. Now if he can do this by creating a mutated army of once-animals, now-armored beasts, then that will just make his day. It will also make him supreme ruler of the planet.

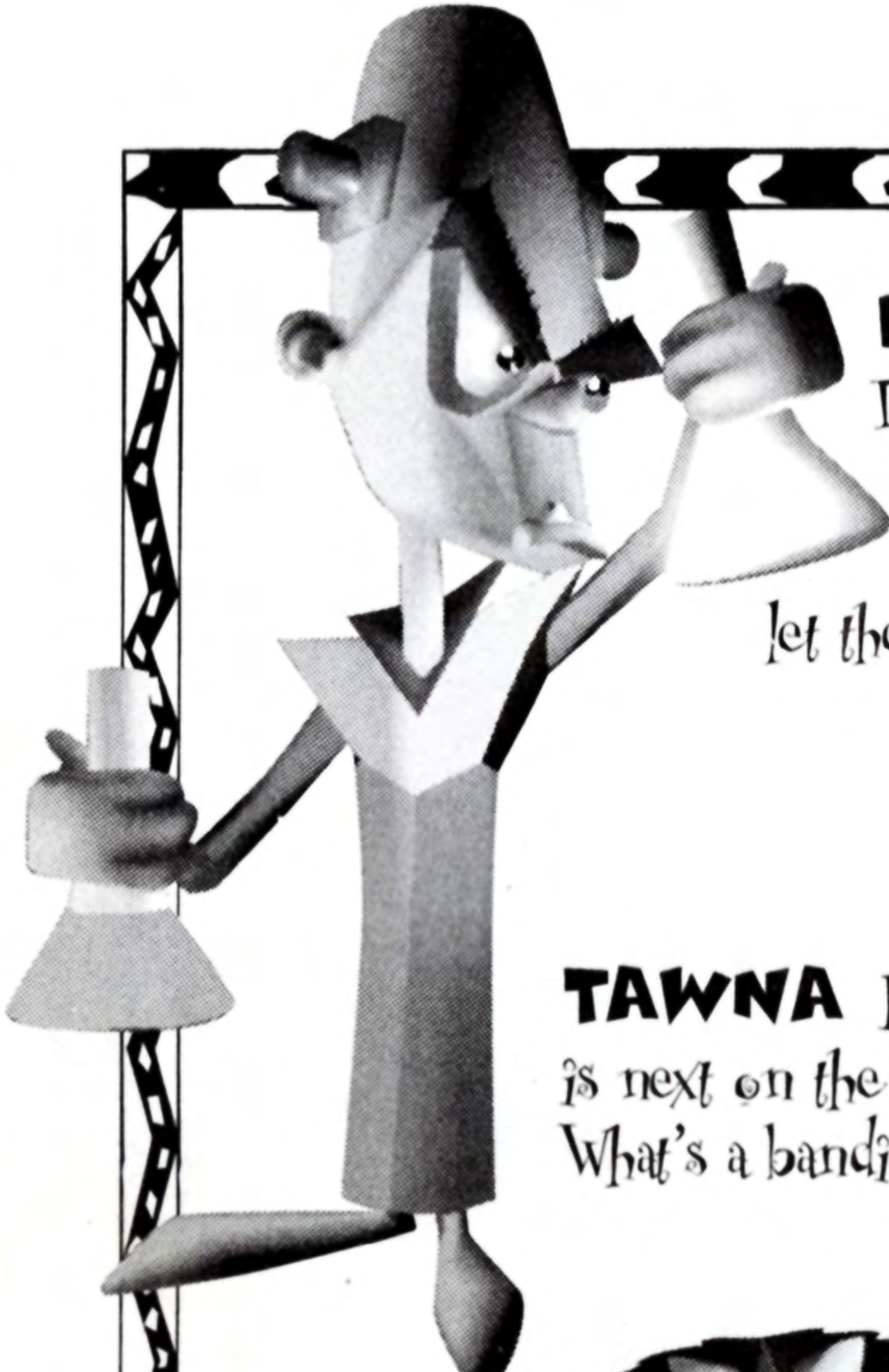

DR. N BRIO Not as pushy or driven as his boss, Dr. N. Brio has relegated his position to chief henchman of Dr. Cortex. Actually, it was Dr. N. Brio who created the Evolve-Ray, but his lack of self-esteem let the other (more twisted) Mad Scientist take the credit.



TAWNA Love of Crash's life, this unfortunate she-bandicoot is next on the list for experimentation by the nasty Doctors. What's a bandicootess to do (other than pout convincingly) to let her hero know he'd better hurry if he wants somebody to come home to.

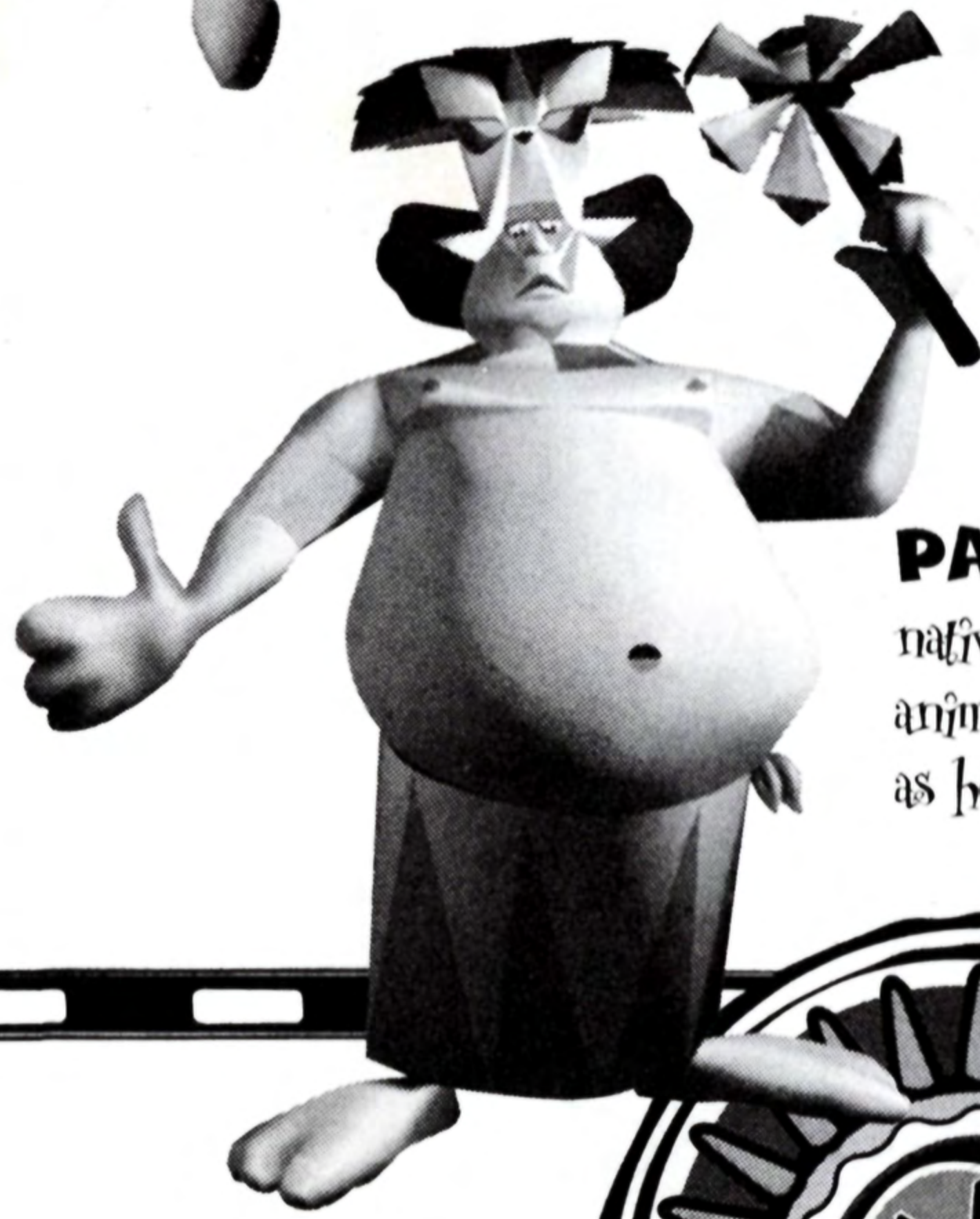

PAPU PAPU We think Papu Papu is native for "Pass me that dish again, mate." This animated mountain of a feller has a fuse as short as he is big.

RIPPER ROO Crazy, demented, not-all-there. These are kind words to describe an animal who has undergone one (or two) zaps of the old Evolve-Ray too many. Not much of a conversationalist either, we hear. Do your best to avoid contact with Ripper Roo and his razor-sharp toe nails.



KOALA KONG So much for a steady diet of peaceful eucalyptus leaves. When Dr. Cortex made this bruiser, he dedicated way too many protons to the muscle department and too few to the brains. He likes to throw rocks. Fine. Do your best to return the favor and you may get to the third (and most dangerous) island - the fortress of Dr. Cortex.



PINSTRIPE Dr. Cortex was looking for a more efficient form of enforcer and created Pinstripe Poteroo, a cross between a local furry omnivore and several cheesy Gangster movies. Pinstripe is loyal to "The Don of Doctors" and makes no bones about protecting his employer with his wits, his skills and a fully loaded Tommy gun.

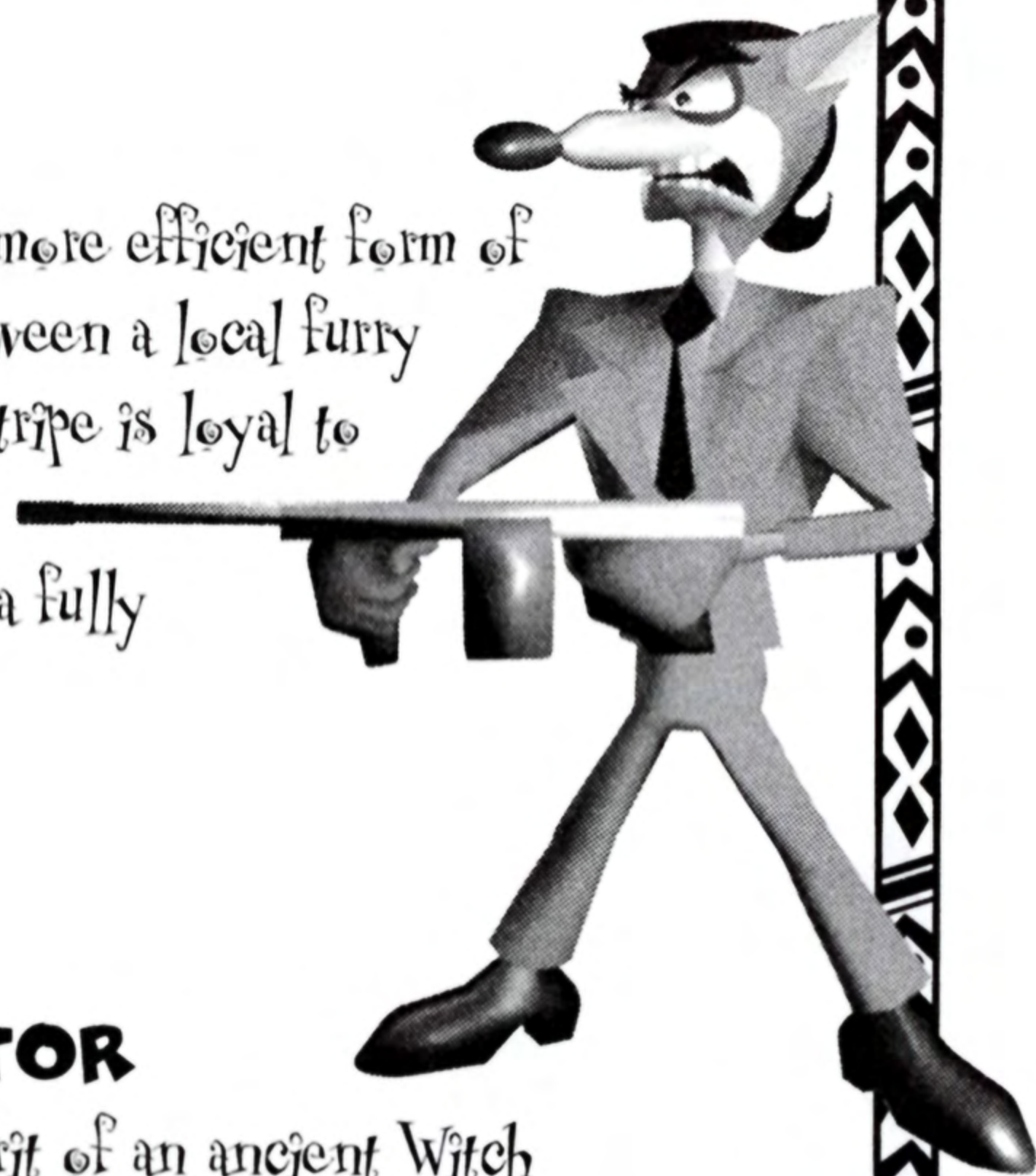

WITCH DOCTOR

Legend has it the spirit of an ancient Witch Doctor named Aku Aku looks over the islands as a benevolent protector. Sensing Crash's mission to thwart Dr. Cortex's plans, Aku Aku has scattered masks throughout the islands to help Crash succeed. With luck, the old Witch Doctor's faith in the Bandicoot won't be misplaced.

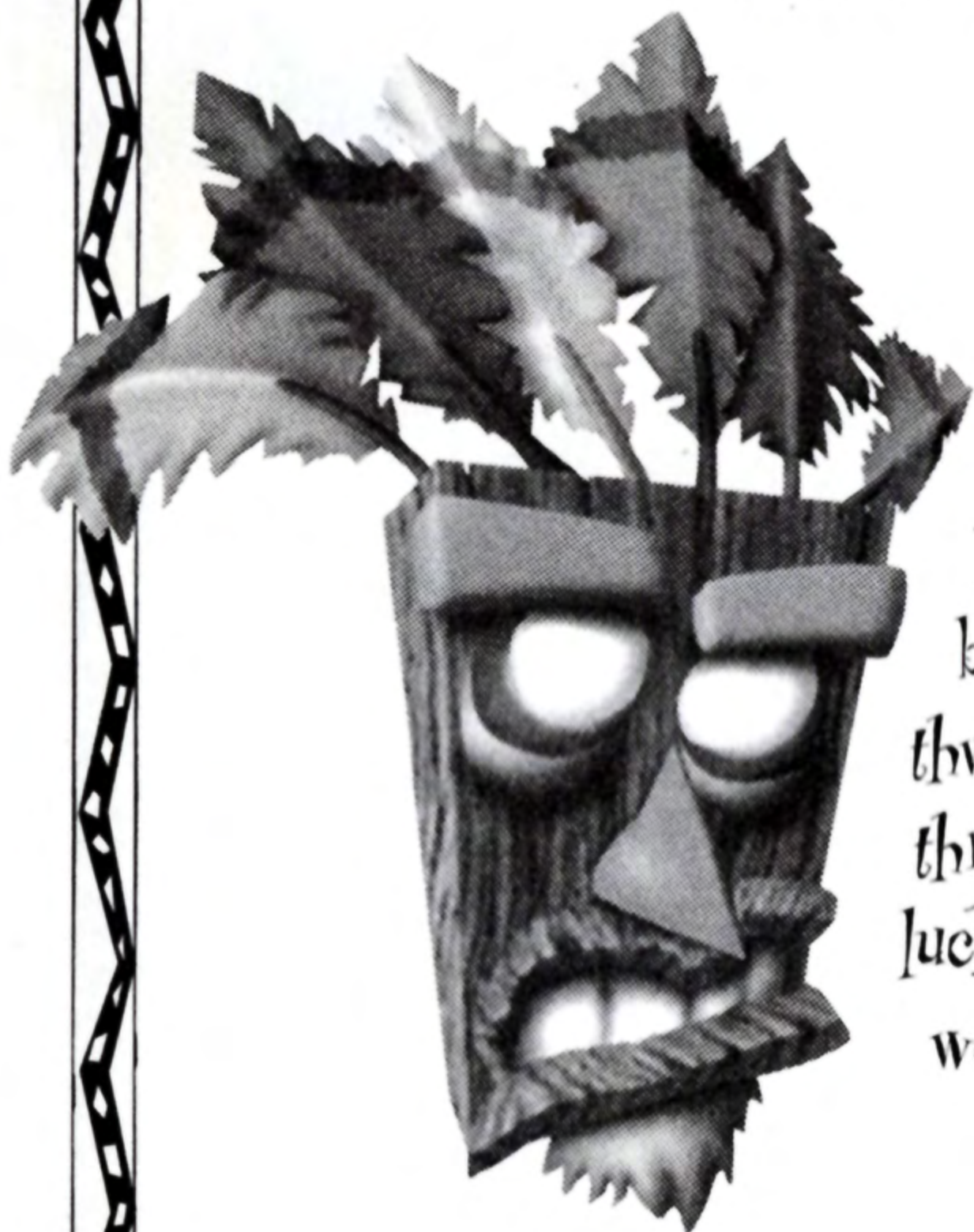

NOTES



CREDITS

Published by:

SONY COMPUTER ENTERTAINMENT
AMERICA

Executive Producer:

ALLAN BECKER

Senior Producer:

CONNIE BOOTH

Assistant Producer:

DAVID GRACIA

Marketing Manager:

AMI MATSUMURA-BLAIRE

Assistant Marketing Manager:

MICHELLE VERCELLI

Marketing Specialist:

NEMER VELASQUEZ

QA Manager:

MARK PENTEK

Lead Analyst:

SCOTT MORRIS

Assistant Lead Analyst:

DONOVAN SOTO

Game Analysts:

BRUCE COCHRANE

CHRIS JOHNSON

TOMASI AKIMETA

MARCUS MONTGOMERY

CHARLES DELAY

PETER MAYBERRY

LEIGHTON CHIN

VICTOR QUIMSON

JO ARAGONES

STEVE DREO

BRETT MULBERG

VP Licensing:

SHUJI UTSUMI

Produced by:

UNIVERSAL INTERACTIVE STUDIOS

Chairman:

ROB BINIAZ

Executive Producer:

MARK CERNY

Producer:

DAVE SILLER

Director of Marketing:

KELLY FLAHERTY

Quality Assurance:

CRAIG PERKINS

Developed by:

NAUGHTY DOG, INC.

ANDY GAVIN

JASON RUBIN

DAVE BAGGETT

BOB RAFEI

TAYLOR KUROSAKI

DAN KOLLMORGEN

JUSTIN MONAST

CHARLOTTE FRANCIS

MORGAN

Character Design and Art Direction:

CHARLES ZEMBILLAS

JOE PEARSON

Production Design:

AMERICAN EXITUS, INC.

Soundtrack:

MUTATO MUZIKA

MARK MOTHERSBAUGH

JOSH MANCELL

Sound Effects:

UNIVERSAL SOUND STUDIOS

MIKE GOLLOM

RON HORWITZ

KEVIN SPEARS

Special Thanks:

PETER DILLE

ANDREW HOUSE

HOWARD LIEBESKIND

BERNIE STOLAR

MOORE & PRICE DESIGN GROUP

SKIP PAUL

ALIAS/WAVEFRONT

SILICON GRAPHICS

WARRANTY

Sony Computer Entertainment America (SCEA) warrants to the original purchaser of this SCEA product that this Game Pak is free from defects in material and workmanship for a period of ninety (90) days from the date of purchase. SCEA agrees for a period of ninety (90) days to either repair or replace, at its option, the SCEA product. You must call 1•800•345•SONY to receive instructions to obtain repair/replacement services.

This warranty shall not be applicable and shall be void if the defect in the SCEA product has arisen through abuse, unreasonable use, mistreatment or neglect. THIS WARRANTY IS IN LIEU OF ALL OTHER WARRANTIES AND NO OTHER REPRESENTATIONS OR CLAIMS OF ANY NATURE SHALL BE BINDING ON OR OBLIGATE SCEA. ANY IMPLIED WARRANTIES APPLICABLE TO THIS SOFTWARE PRODUCT, INCLUDING WARRANTIES OF MERCHANTABILITY AND FITNESS FOR A PARTICULAR PURPOSE, ARE LIMITED TO THE NINETY (90) DAY PERIOD DESCRIBED ABOVE. IN NO EVENT WILL SCEA BE LIABLE FOR INCIDENTAL OR CONSEQUENTIAL DAMAGES RESULTING FROM POSSESSION, USE OR MALFUNCTION OF THE SCEA SOFTWARE PRODUCT.

Some states do not allow limitations as to how long an implied warranty lasts and/or exclusions or limitations of consequential damages, so the above limitations and/or exclusions of liability may not apply to you. This warranty gives you specific legal rights, and you may also have other rights which vary from state to state.

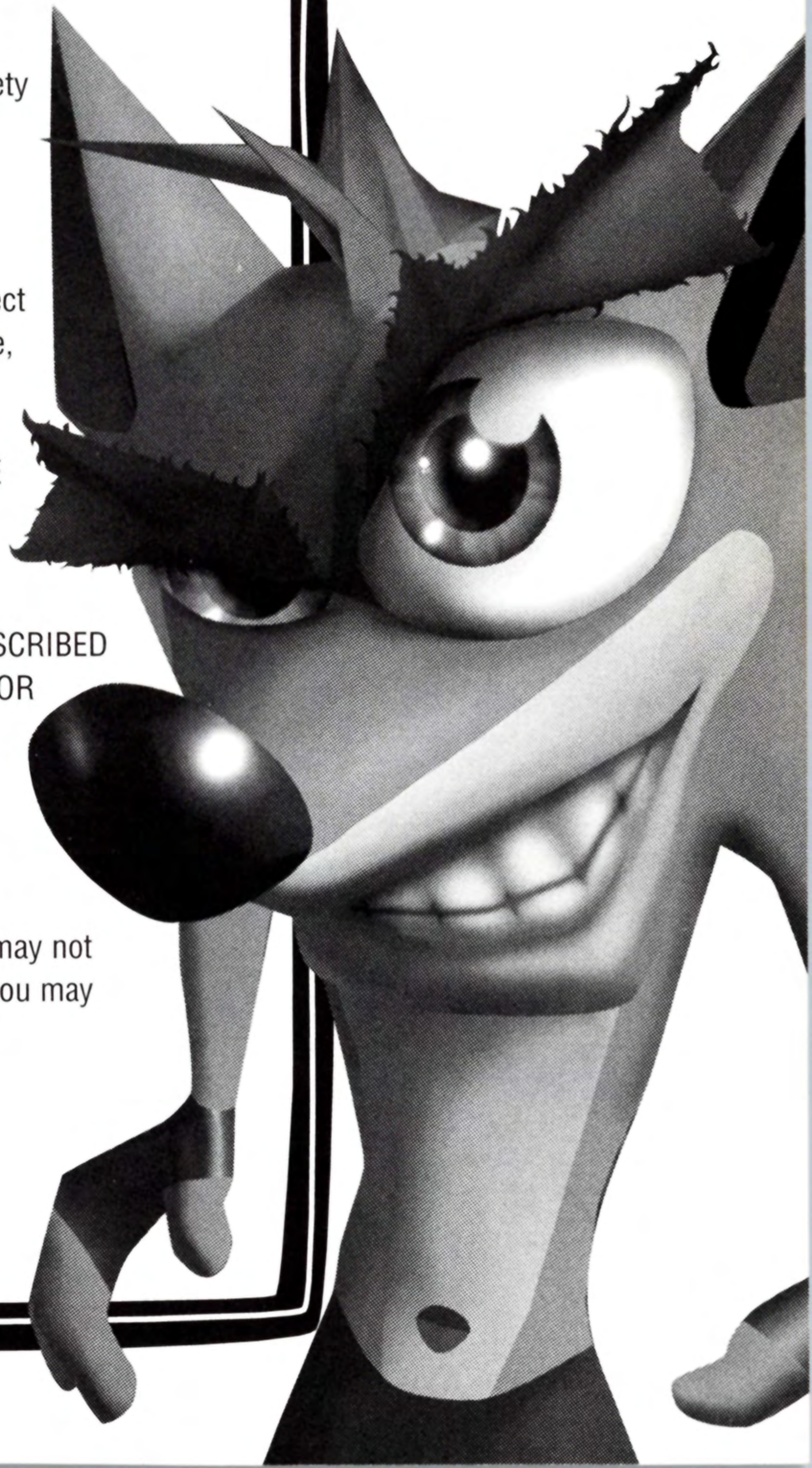



PlayStation

TM

NTSC U/C

PlayStation™

CRASH

BANDICOOT™



KIDS TO ADULTS



CONTENT RATED BY
ESRB

SCUS-94900
94900

NAUGHTY DOG™

universal interactive studios®



SONY



COMPUTER
ENTERTAINMENT™